

# EEV-EX16

COM Express Type 6 Evaluation Carrier Board

## User's Manual

---

2<sup>nd</sup> Ed – 03 June 2020

# Contents

<b>1.</b>	<b>Getting Started</b> .....	<b>4</b>
1.1	Safety Precautions .....	4
1.2	Packing List .....	4
1.3	Document Amendment History.....	5
1.4	System Specifications .....	6
1.5	Architecture Overview—Block Diagram.....	8
<b>2.</b>	<b>Hardware Configuration</b> .....	<b>9</b>
2.1	Product Overview .....	10
2.2	Jumper and Connector List.....	11
2.3	Setting Jumpers & Connectors .....	13
2.3.1	Multi-function select (SW1).....	13
2.3.2	Clear CMOS (JBAT1) .....	14
2.3.3	General Purpose I/O connector (JDIO1) .....	14
2.3.4	ATX1 Power connector (ATX1) .....	15
2.3.5	ATX2 Power connector (ATX2) .....	15
2.3.6	CPU Fan connector (CPU_FAN1).....	16
2.3.7	System Fan connector (SYS_FAN1).....	16
2.3.8	TAG connector (JTAG1).....	17
2.3.9	Front panel connector (JFP1).....	17
2.3.10	LCD backlight brightness adjustment (JVR1).....	18
2.3.11	LCD Inverter connector (JBKL1) .....	18
	2.3.11.1 Signal Description – LCD Inverter connector (JBKL1) .....	18
2.3.12	LPC port connector (JLPC1) .....	19
2.3.13	Battery connector (BH1) .....	19
2.3.14	LVDS connector (LVDS1).....	20
2.3.15	USB connector (USB2_1).....	20
2.3.16	EDP connector (EDP1).....	21
2.3.17	Test position connector (JTP1) .....	21
2.3.18	IET connector (IET_CB1) only used in production testing .....	22
2.3.19	COM Express connector (CN1).....	23
	2.3.19.1 Signal Description – COM Express connector (CN1) .....	31
	2.3.19.1.1 Audio Signals.....	31
	2.3.19.1.2 Gigabit Ethernet Signals .....	31
	2.3.19.1.3 PCI Express Signals .....	31
	2.3.19.1.4 Flat Panel LVDS Signals.....	31
	2.3.19.1.5 LPC Signals.....	32
	2.3.19.1.6 GPIO Signals.....	32

2.3.19.1.7	Power & System Management Signals.....	32
2.3.19.1.8	SATA Signals .....	32
2.3.19.1.9	USB Signals .....	33
2.3.19.1.10	I2C Signals .....	33
2.3.19.1.11	USB3.0 Signals .....	33
2.3.19.1.12	DDI Signals.....	33
2.3.19.1.13	USB3.0 Signals .....	34
2.3.19.1.14	DDI Signals.....	34
2.3.19.1.15	PEG PCI Express Lanes Signals .....	34
<b>2.4</b>	<b>EEV-EX16 DB-A PCIe Expansion Boards .....</b>	<b>35</b>
<b>2.5</b>	<b>EEV-EX16 Expansion Boards Jumper &amp; Connector list .....</b>	<b>35</b>
<b>2.6</b>	<b>EEV-EX16 DB-A PCIe Expansion board Setting .....</b>	<b>36</b>
2.6.1	+12V VIN Power select (AJPWR1/2) .....	36
2.6.2	Power connector (ACN1).....	36
2.6.3	Gold Finger (AGF1) .....	37
<b>3.</b>	<b>Mechanical Drawing .....</b>	<b>38</b>

# 1. Getting Started

## 1.1 Safety Precautions

### Warning!



Always completely disconnect the power cord from your chassis whenever you work with the hardware. Do not make connections while the power is on. Sensitive electronic components can be damaged by sudden power surges. Only experienced electronics personnel should open the PC chassis.

### Caution!



Always ground yourself to remove any static charge before touching the CPU card. Modern electronic devices are very sensitive to static electric charges. As a safety precaution, use a grounding wrist strap at all times. Place all electronic components in a static-dissipative surface or static-shielded bag when they are not in the chassis.

## 1.2 Packing List

Before you begin installing your single board, please make sure that the following materials have been shipped:

- 1 x EEV-EX16 COM Express Type 6 Evaluation Carrier Board
- 1 x Expansion board for PCIe
- 8 x M3\*5mm Ni Screws for installing Carrier Board
- 1 x Desiccant (5g)



---

If any of the above items is damaged or missing, contact your retailer.

---

### 1.3 Document Amendment History

Revision	Date	By	Comment
1 <sup>st</sup>	December 2019	Avalue	Initial Release
2 <sup>nd</sup>	June 2020	Avalue	Update 1.2 Packing List

## 1.4 System Specifications

<b>System</b>	
<b>BIOS</b>	SPI FLASH SOIC 8PIN SOCKET
<b>Expansion</b>	2PCIe Slot x 4, 1 PCIe x16 1 x SDIO/DIO (optional, depend on module board) 1 x IET
<b>I/O</b>	
<b>MIO</b>	4 x SATAIII
<b>USB</b>	4 x USB 3.2 (Gen2/10Gbps,contain 4 x USB2.0), 4 x USB2.0 (OTG design is reserved)
<b>GPIO</b>	8-bit GPIO
<b>Display</b>	
<b>HDMI</b>	PTN3360DBS
<b>Audio</b>	
<b>AC97 Codec</b>	ALC892
<b>Internal I/O Connectors</b>	
<b>Power ON</b>	ATX, One 12 x 2-pin & 2 x 2-pin(12V Aux Power) Connector
<b>GPIO</b>	8-bit GPIO
	1 x COM Express connector (connector row AB,CD)
<b>Miscellaneous Setting Connector</b>	RTC Battery x 1,DIOx4/SDIOX1(Mux with GPIO)
<b>IET</b>	1 x IET (eSPI: Reserved design in IET)
<b>LVDS</b>	1 x LVDS
<b>eDP</b>	1 x eDP
<b>USB</b>	2 x (5 x 2 pin header) for USB 2.0
<b>Rear I/O Connectors</b>	
<b>USB</b>	4 x USB 3.2 (Gen2/10Gbps,contain 4 x USB2.0) 2 x USB2.0
<b>LAN</b>	1 x RJ45
<b>HDMI</b>	3 x DP/HDMI Connector (3 x HDMI, 3 x DP)
<b>Audio</b>	MIC In & Line Out
<b>VGA</b>	1 x VGA
<b>Mechanical &amp; Environmental</b>	
<b>Power Type</b>	ATX
<b>Operating Temp.</b>	Standard: 0°C to 60°C (32°F ~ 140°F)
<b>Storage Temp.</b>	-40°C to +85°C (-40°F ~ 185°F)

<b>Operating Humidity</b>	40°C @ 95% Relative Humidity, Non-condensing
<b>Size (L x W)</b> (Please consult product engineers for the production feasibility if the size is larger than 410 x 360mm or smaller than 80 x 70mm)	243.84 mm x 243.84 mm (Micro-ATX Form Factor)
<b>OS Support</b> (listed in accordance with Intel document)	According to COMe Module solution



**Note:** Specifications are subject to change without notice.

## 1.5 Architecture Overview—Block Diagram

The following block diagram shows the architecture and main components of EEV-EX16.

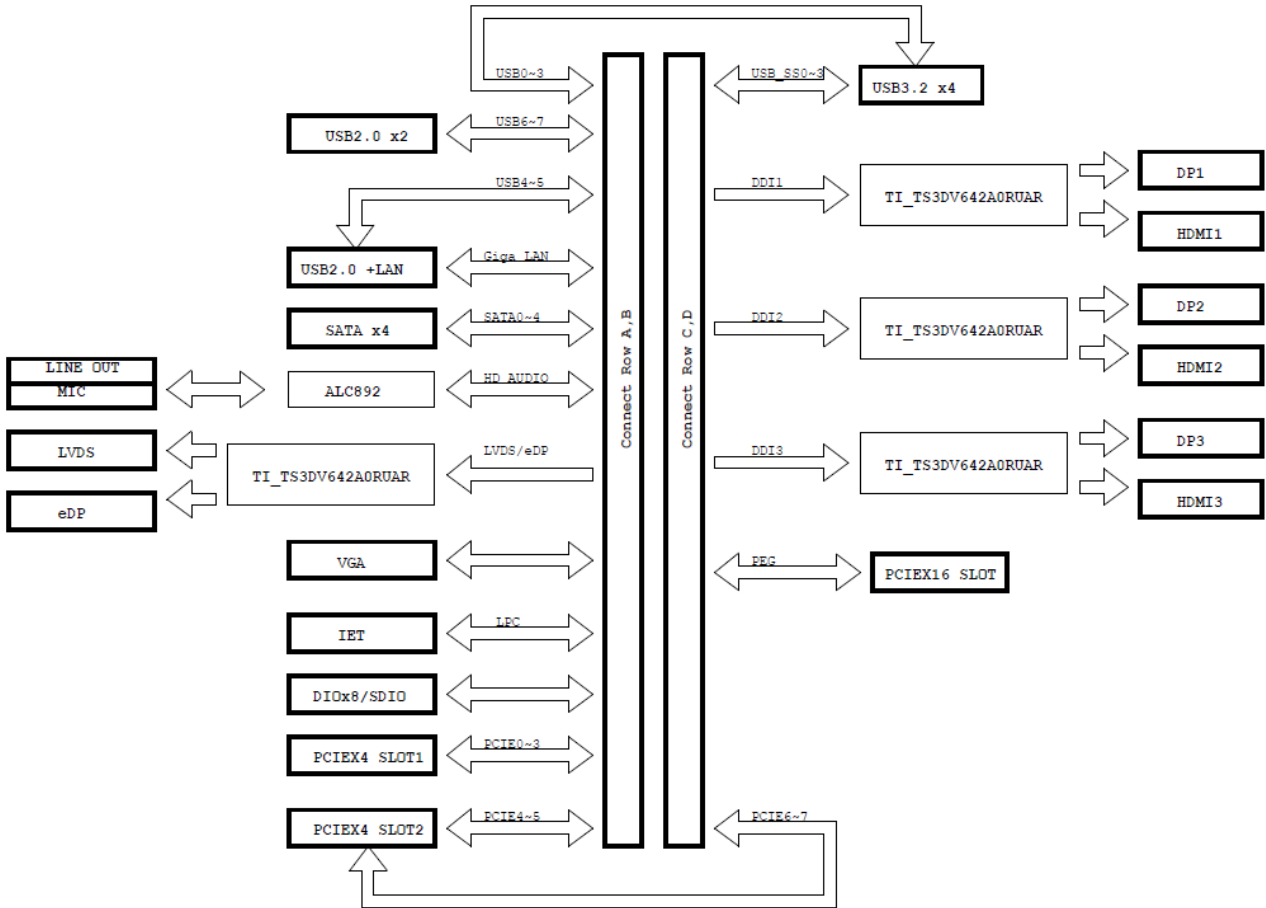



## 2. Hardware Configuration

---

## 2.1 Product Overview

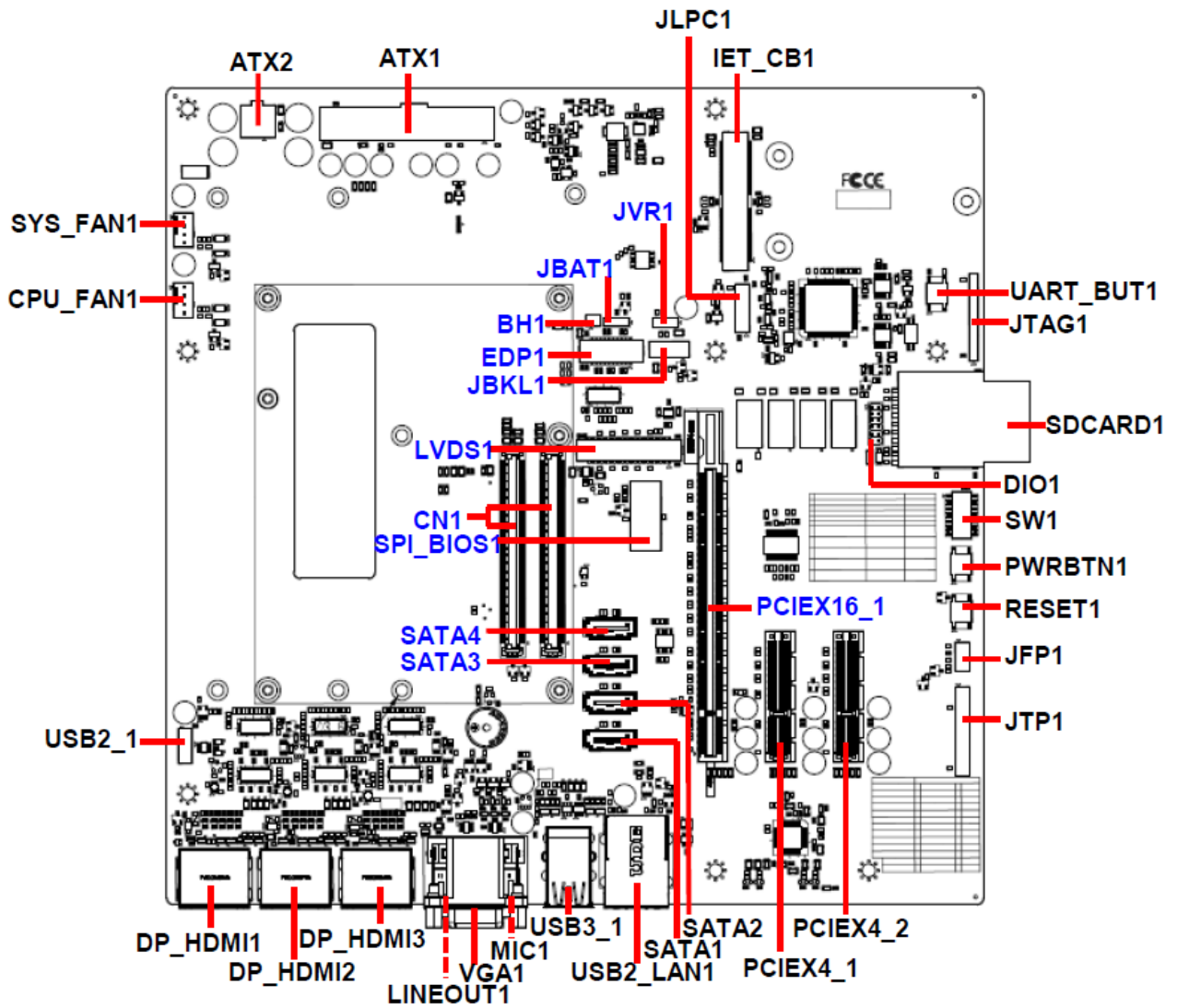

## 2.2 Jumper and Connector List

You can configure your board to match the needs of your application by setting jumpers. A jumper is the simplest kind of electric switch.

It consists of two metal pins and a small metal clip (often protected by a plastic cover) that slides over the pins to connect them. To “close” a jumper you connect the pins with the clip. To “open” a jumper you remove the clip. Sometimes a jumper will have three pins, labeled 1, 2, and 3. In this case, you would connect either two pins.

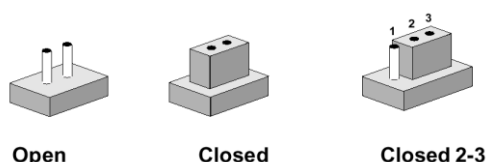

The jumper settings are schematically depicted in this manual as follows:



A pair of needle-nose pliers may be helpful when working with jumpers.

Connectors on the board are linked to external devices such as hard disk drives, a keyboard, or floppy drives. In addition, the board has a number of jumpers that allow you to configure your system to suit your application.

If you have any doubts about the best hardware configuration for your application, contact your local distributor or sales representative before you make any changes.

The following tables list the function of each of the board's jumpers and connectors.

### Jumpers

Label	Function	Note
SW1	Multi-function select	DIP switch 10pin
JBAT1	Clear CMOS	3 x 1 header, pitch 2.54mm

### Connectors

Label	Function	Note
ATX1	ATX1 Power connector	12 x 2 wafer, pitch 4.20mm
ATX2	ATX2 Power connector	2 x 2 wafer, pitch 4.20mm
CPU_FAN1	CPU Fan connector	4 x 1 wafer, pitch 2.54mm
SYS_FAN1	System Fan connector	4 x 1 wafer, pitch 2.54mm
DP_HDMI1/2/3	3 x Display port connector 3 x HDMI connector	

## EEV-EX16 User's Manual

<b>SDCARD1</b>	SD card slot	
<b>JTP1</b>	Test position connector	13 x 2 header, pitch 2.00mm
<b>IET_CB1</b>	IET connector	40 x 2 wafer, pitch 0.80mm (only used in production testing)
<b>JTAG1</b>	TAG connector	10 x 1 header, pitch 2.54mm
<b>JVR1</b>	LCD backlight brightness adjustment	3 x 1 header, pitch 2.54mm
<b>JBKL1</b>	LCD Inverter connector	5 x 1 wafer, pitch 2.00mm Matching Connector: JST PHR-5
<b>DIO1</b>	General Purpose I/O connector	6 x 2 header, pitch 2.00mm
<b>JFP1</b>	Front panel connector	4 x 2 header, pitch 2.00mm
<b>UART_BUT1</b>	UART button	
<b>PWRBTN1</b>	Power button	
<b>RESET1</b>	Reset button	
<b>USB2_LAN1</b>	2 x USB2.0 connector 1 x Ethernet connector	
<b>USB3_1</b>	4 x USB3.2 connector	
<b>USB2_1</b>	USB connector	5 x 2 header, pitch 2.00mm
<b>PCIEX4_1</b>	PCIx4 Express connector 1	
<b>PCIEX4_2</b>	PCIx4 Express connector 2	
<b>PCIEX16_1</b>	PCIx16 Express connector	
<b>SATA1/2/3/4</b>	4 x Serial ATA connector	
<b>LVDS1</b>	LVDS connector	20 x 2 box header, pitch 1.25 mm Matching Connector: Hirose DF13-40DS-1.25C
<b>JLPC1</b>	LPC port connector	7 x 2 header, pitch 2.00mm
<b>EDP1</b>	EDP connector	10 x 2 wafer, pitch 1.25mm
<b>BH1</b>	Battery connector	2 x 1 wafer, pitch 1.25mm
<b>VGA1</b>	VGA connector	
<b>LINEOUT1</b>	Audio line-out connector	
<b>MIC1</b>	Audio mic-in connector	
<b>SPI_BIOS1</b>	(Reserved for BIOS programming)	5 x 2 header, pitch 2.00mm
<b>CN1</b>	COM Express connector	

## 2.3 Setting Jumpers & Connectors

### 2.3.1 Multi-function select (SW1)

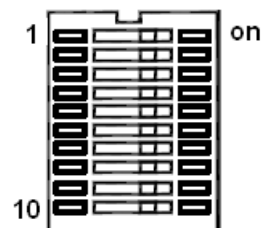
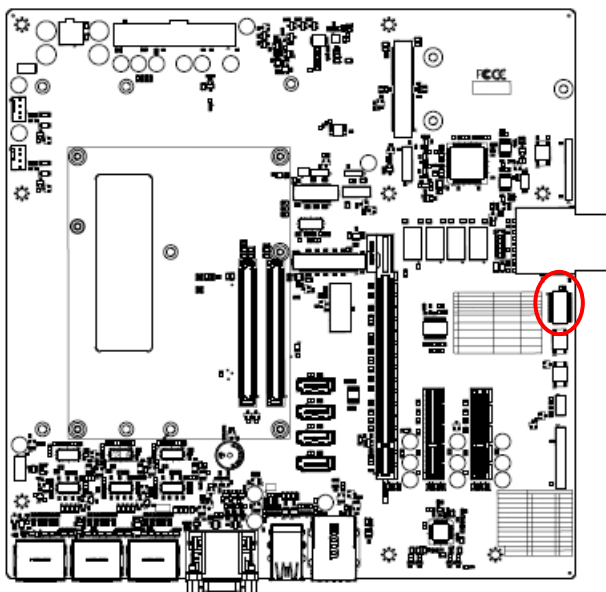

	Function	ON	OFF
1	BIOS ROM select		Default
2	BIOS ROM select		Default
3	LPC/eSPI select	eSPI	LPC
4	ERP setting	ERP ON	ERP OFF
5	PSON Control	Power button	S3
6	DP/HDMI select1 (optional)	DP1	HDMI1
7	DP/HDMI select2 (optional)	DP2	HDMI2
8	DP/HDMI select3 (optional)	DP3	HDMI3
9	LVDB/eDP select (optional)	LVDB	Edp
10	PCIeX16 Reverse select	Reverse	Normal

### 2.3.2 Clear CMOS (JBAT1)

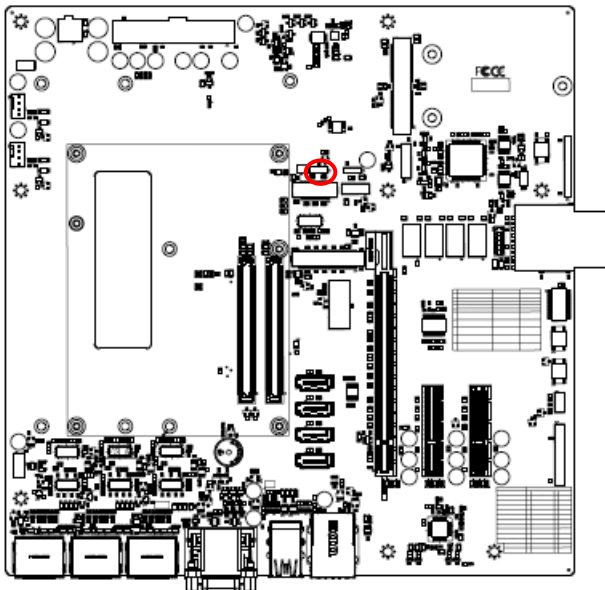

Protect\*

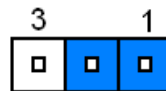

Clear CMOS

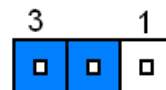

\* Default

### 2.3.3 General Purpose I/O connector (JDIO1)

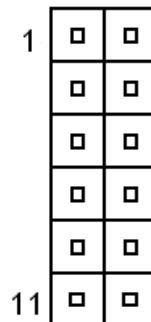
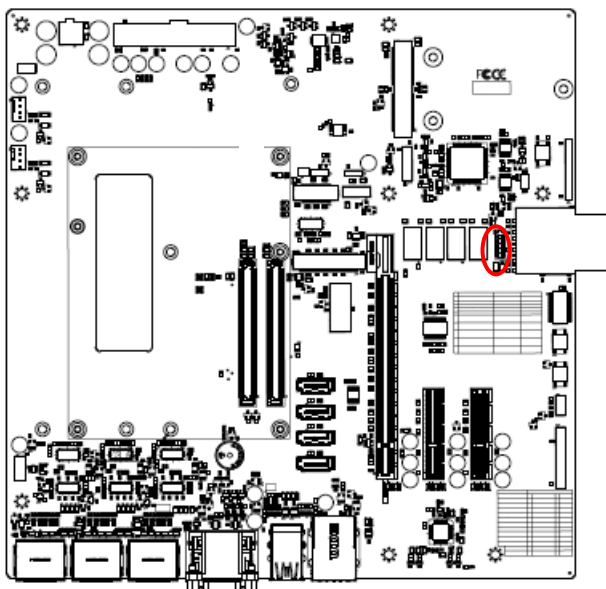

Signal	PIN	PIN	Signal
DIO_OUT0_SD_CLK	1	2	DIO_IN0_SD_DATA0
DIO_OUT1_SD_CMD	3	4	DIO_IN1_SD_DATA1
DIO_OUT2_SD_WP	5	6	DIO_IN2_SD_DATA2
DIO_OUT3_SD_CD#	7	8	DIO_IN3_SD_DATA3
SMB_CLK	9	10	SMB_DAT
GND	11	12	+5V

### 2.3.4 ATX1 Power connector (ATX1)

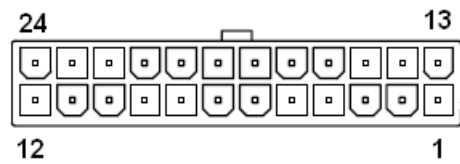
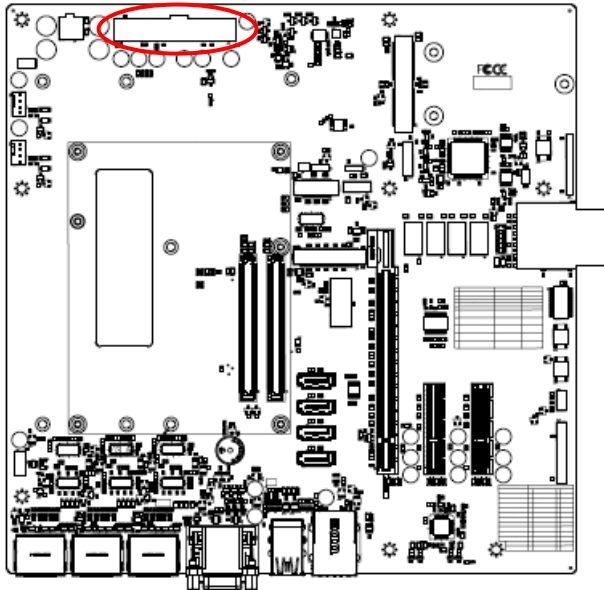

Signal	PIN	PIN	Signal
+3.3V	13	1	+3.3V
NC	14	2	+3.3V
GND	15	3	GND
PSON#	16	4	+5V
GND	17	5	GND
GND	18	6	+5V
GND	19	7	GND
NC	20	8	PWR_OK
+5V	21	9	+5VSB
+5V	22	10	+12V
+5V	23	11	+12V
GND	24	12	+3.3V

### 2.3.5 ATX2 Power connector (ATX2)

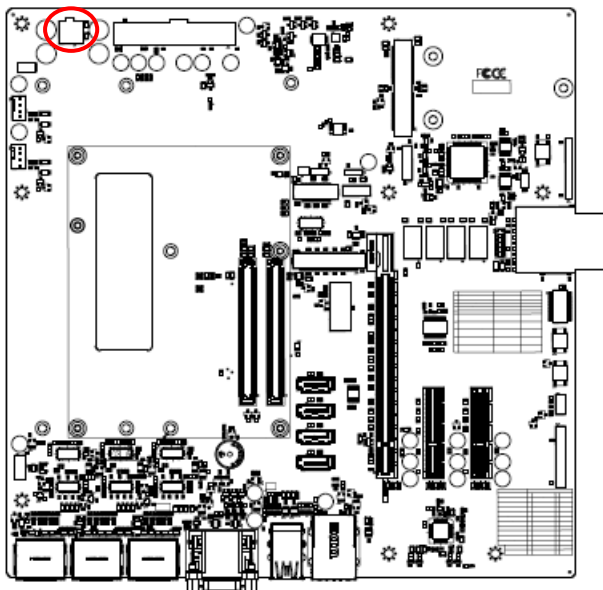

Signal	PIN	PIN	Signal
+VIN	4	3	+VIN
GND	2	1	GND

### 2.3.6 CPU Fan connector (CPU\_FAN1)

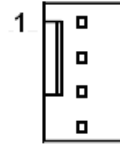
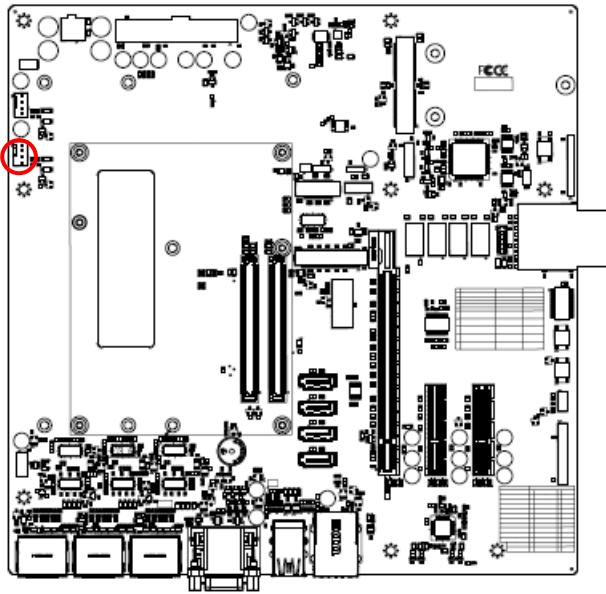

Signal	PIN
GND	1
+12V	2
FAN_TACHIM	3
+5V	4

### 2.3.7 System Fan connector (SYS\_FAN1)

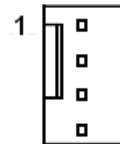
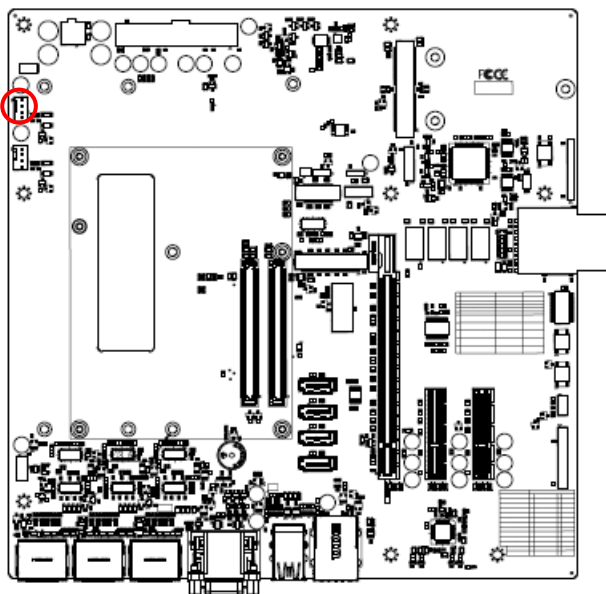

Signal	PIN
GND	1
+12V	2
SYS_FAN_TACHIM	3
+5V	4



### 2.3.8 TAG connector (JTAG1)

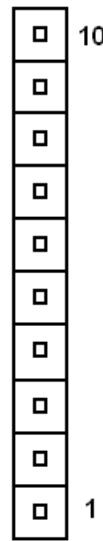
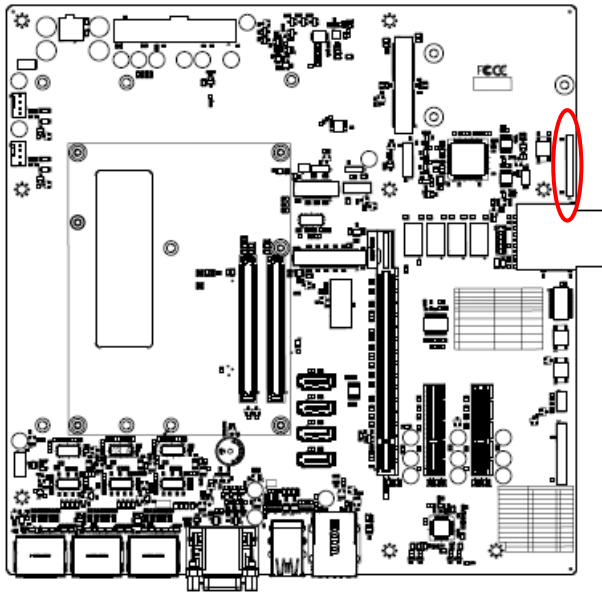

Signal	PIN
+3.3V	10
GAL1_EN	9
I2C_CLK_UART_RX	8
I2C_DAT_UART_TX	7
GND	6
GAL1_TMS	5
GAL1_TDI	4
GAL1_TDO	3
GAL1_TCK	2
+3.3V	1

### 2.3.9 Front panel connector (JFP1)

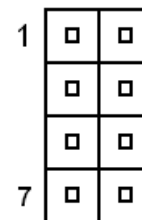
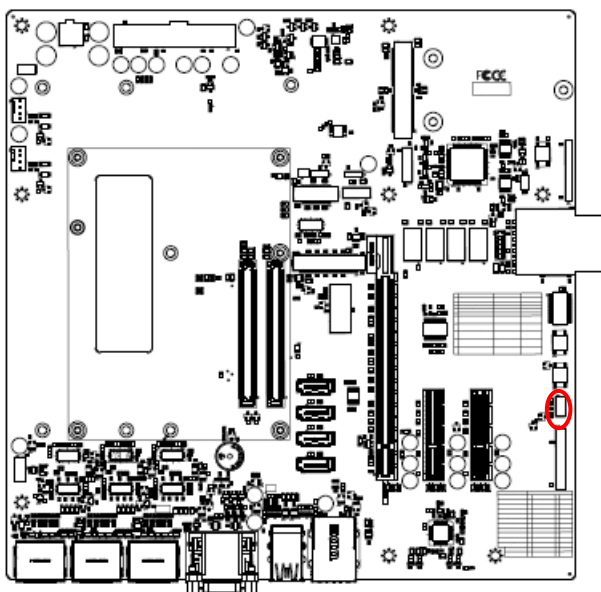

Signal	PIN	PIN	Signal
EXT_PWRBTN#	1	2	GND
SYS_RERST#	3	4	GND
+5V	5	6	GND
+5V	7	8	SATA_LED_OUT#

Pin	1	2	3	4	5	6	7	8
Signal	Power Button		Reset		Power LED		SATA LED	

2.3.10 LCD backlight brightness adjustment (JVR1)

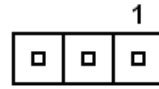
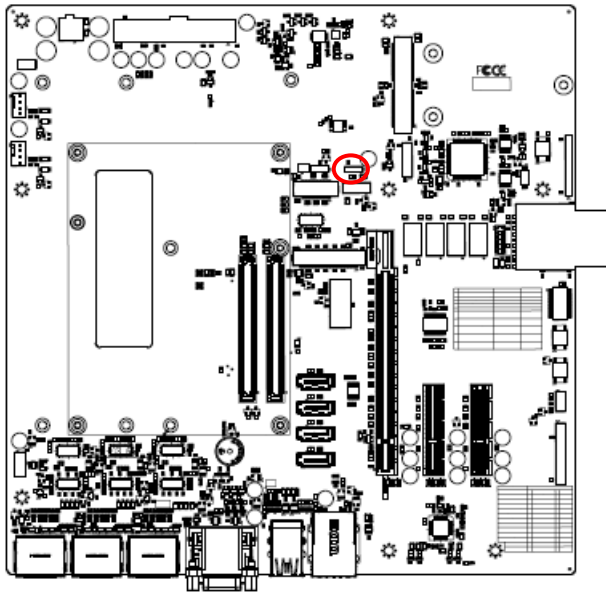

Signal	PIN
+5V	1
EDP_BRIGHT_CTRL	2
GND	3

2.3.11 LCD Inverter connector (JBKL1)

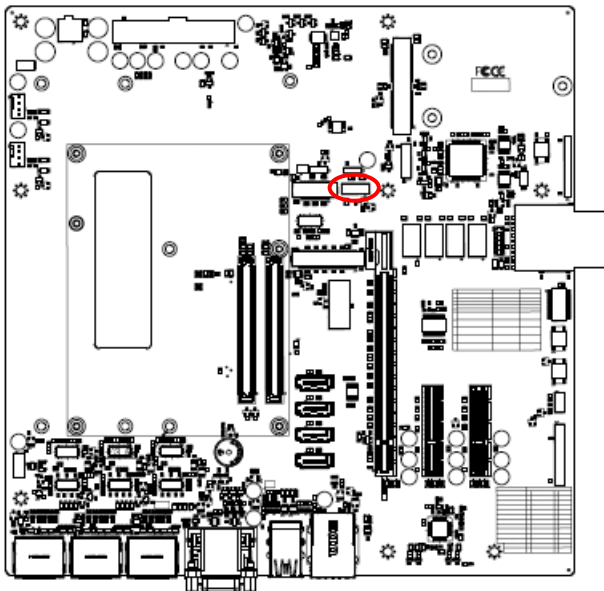

Signal	PIN
+VCC_BKL	1
GND	2
BKLEN	3
EDP_BRIGHT_CTRL	4
+5V	5

2.3.11.1 Signal Description – LCD Inverter connector (JBKL1)

Signal	Signal Description
LVDS_BKLT_CTRL	when LVDS_BKLT_CTRL is controlled by carrier board's JVR1, $V_{adj} = 0.75V \sim 4.25V$ (Recommended: $4.7K\Omega, >1/16W$ )
BKLEN	LCD backlight ON/OFF control signal

### 2.3.12 LPC port connector (JLPC1)

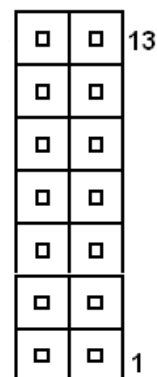
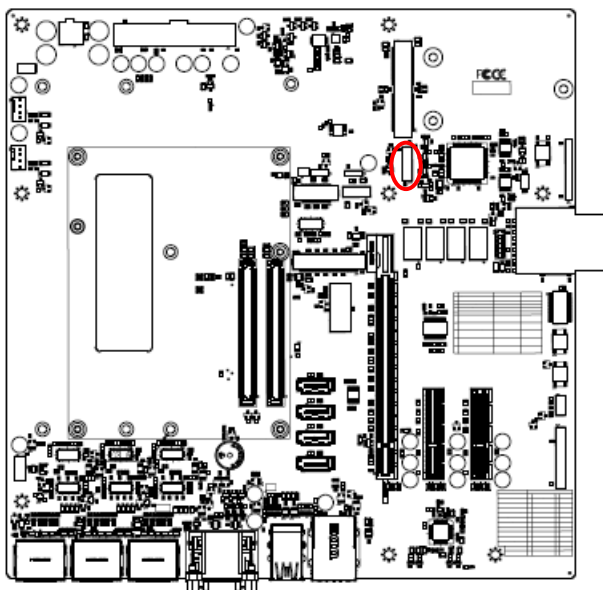

Signal	PIN	PIN	Signal
LPC_DRQ1#/ESPI_ALERT1	14	13	+5VSB
GND	12	11	+5V
GND	10	9	LPC_SERIRQ/ESPI_CS1#
PORT80_CLK	8	7	LPC_AD3/ESPI_IO_3
LPC_FRAME#/ESPI_CS0#	6	5	LPC_AD2/ESPI_IO_2
JLPC_RST#	4	3	LPC_AD1/ESPI_IO_1
+3.3V	2	1	LPC_AD0/ESPI_IO_0

### 2.3.13 Battery connector (BH1)

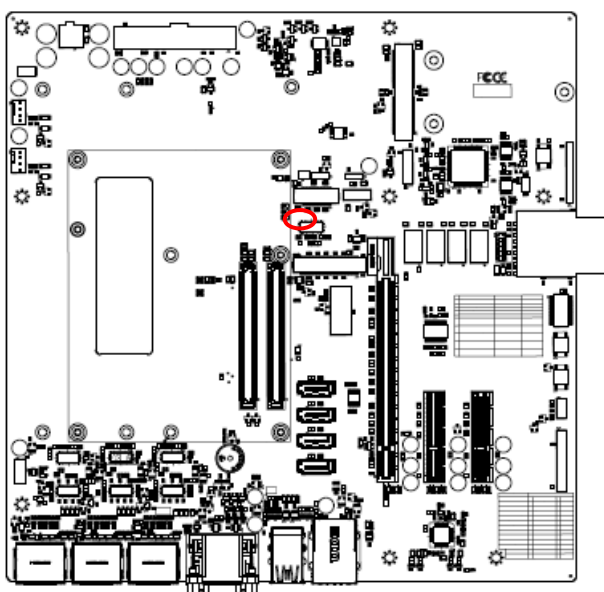

Signal	PIN
+3.3VSB	1
GND	2

# EEV-EX16 User's Manual

## 2.3.14 LVDS connector (LVDS1)

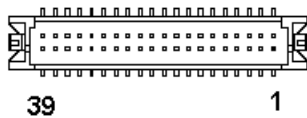
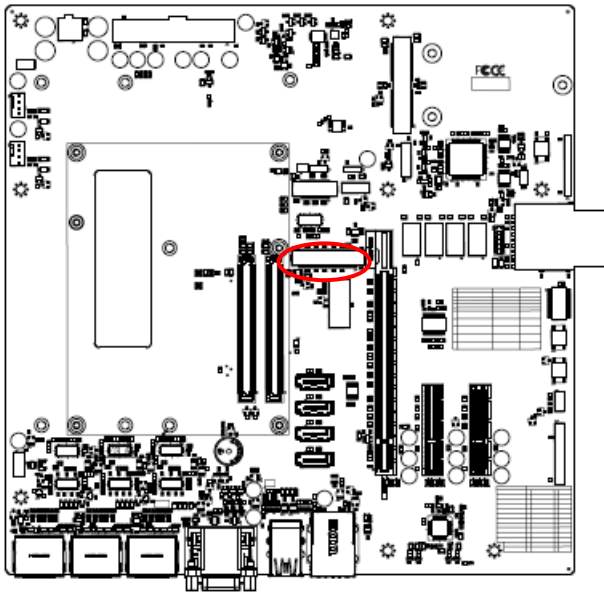

Signal	PIN	PIN	Signal
+5V	2	1	+3.3V
+5V	4	3	+3.3V
LVDS_DDC_SD	6	5	LVDS_DDC_SC
GND	8	7	GND
LVDSA_DATA0	10	9	LVDSA_DATA1
LVDSA_DATA0#	12	11	LVDSA_DATA1#
GND	14	13	GND
LVDSA_DATA2	16	15	LVDSA_DATA3
LVDSA_DATA2#	18	17	LVDSA_DATA3#
GND	20	19	GND
LVDSB_DATA0	22	21	LVDSB_DATA1
LVDSB_DATA0#	24	23	LVDSB_DATA1#
GND	26	25	GND
LVDSB_DATA2	28	27	LVDSB_DATA3
LVDSB_DATA2#	30	29	LVDSB_DATA3#
GND	32	31	GND
LVDSA_CLK	34	33	LVDSB_CLK
LVDSA_CLK#	36	35	LVDSB_CLK#
GND	38	37	GND
+12V	40	39	+12V

## 2.3.15 USB connector (USB2\_1)

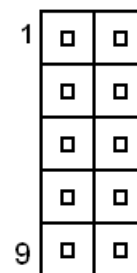
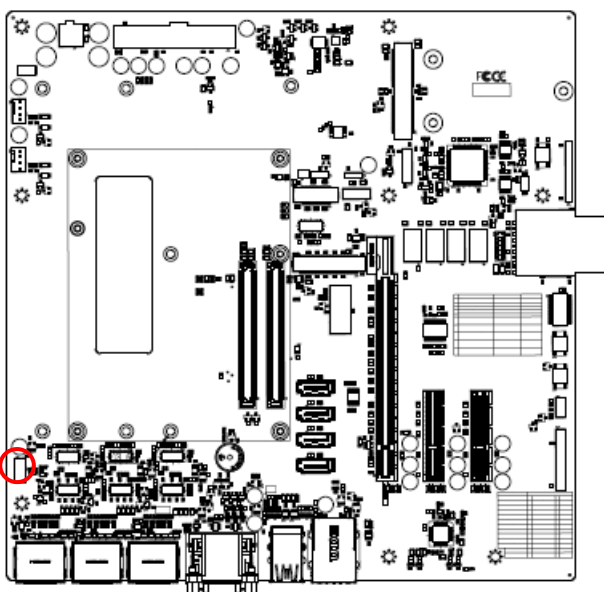

Signal	PIN	PIN	Signal
+5V	1	2	GND
USB_Z_PN6	3	4	GND
USB_Z_PP6	5	6	USB_Z_PP7
GND	7	8	USB_Z_PN7
GND	9	10	+5V

### 2.3.16 EDP connector (EDP1)

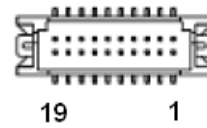
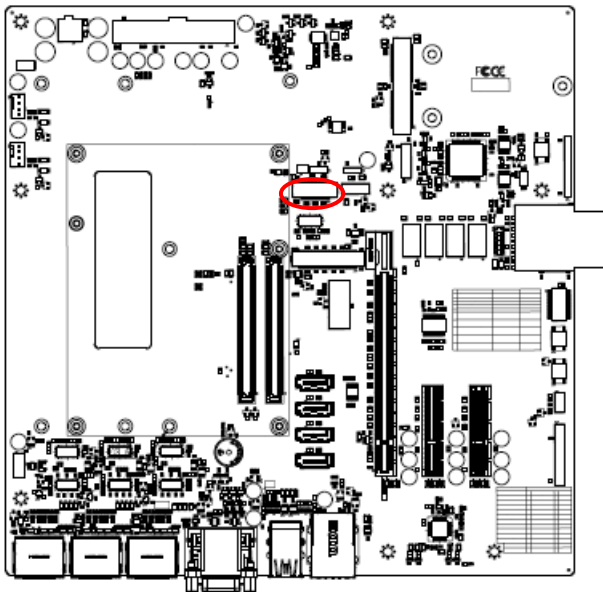

Signal	PIN	PIN	Signal
GND	2	1	GND
EDP_TX3#	4	3	EDP_TX0#
EDP_TX3	6	5	EDP_TX0
NC	8	7	GND
GND	10	9	EDP_TX1#
EDP_AUX#	12	11	EDP_TX1
EDP_AUX	14	13	GND
GND	16	15	EDP_TX2#
EMB_HPDP	18	17	EDP_TX2
+VDD_EDP	20	19	+VDD_EDP

### 2.3.17 Test position connector (JTP1)

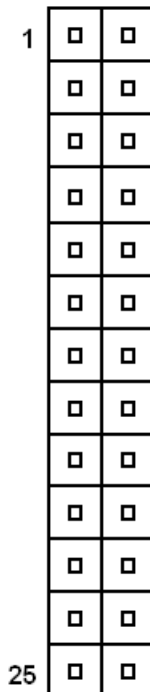
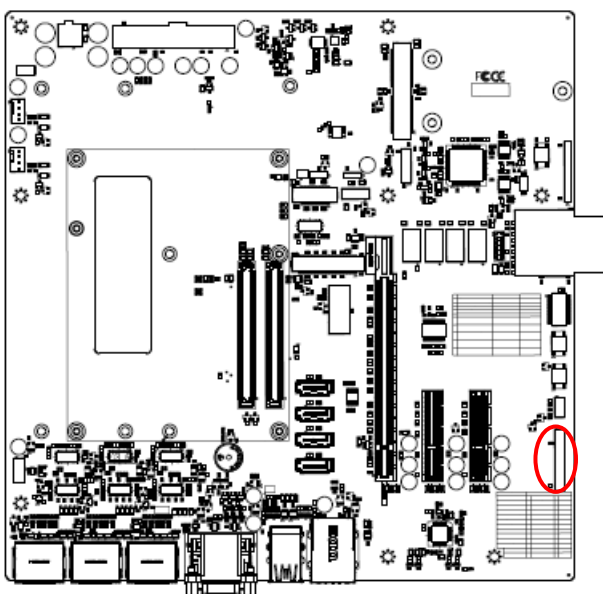

Signal	PIN	PIN	Signal
SER0_TX	1	2	SER0_RX
SER1_TX	3	4	SER1_RX
I2C_CK	5	6	I2C_DAT
TPM_PP	7	8	+3.3VSB
LID#	9	10	GND
SLEEP#	11	12	GND
GBE0_SDP	13	14	GND
USB0_HOST_PRSNTP	15	16	GND
THRM#	17	18	GND
WAKE0#	19	20	GND
WAKE1#	21	22	GND
BATLOW#	23	24	GND
RAPID_SHUTDOWN	25	26	+5VSB

2.3.18 IET connector (IET\_CB1) only used in production testing

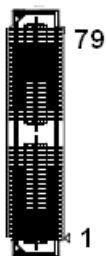
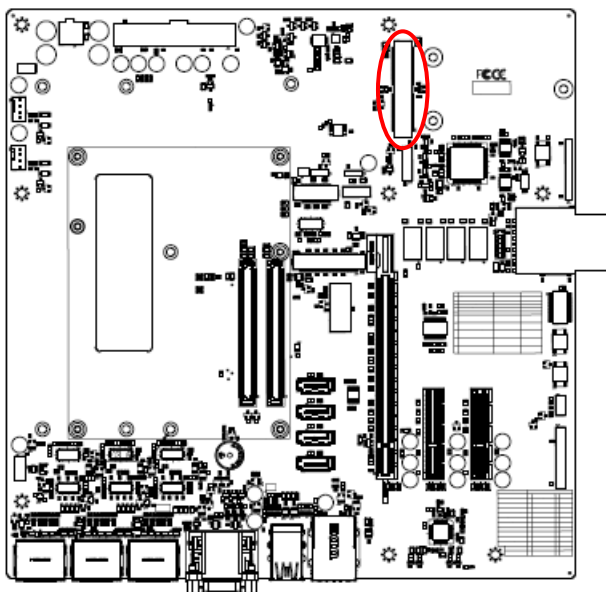

Signal	PIN	PIN	Signal
+12V	80	79	+12V
NC	78	77	GND
GND	76	75	NC
SYS_FAN_PWMOUT	74	73	NC
SYS_FAN_TACHIM	72	71	GND
GND	70	69	NC
NC	68	67	NC
NC	66	65	GND
GND	64	63	NC
NC	62	61	NC

Signal	PIN	PIN	Signal
NC	60	59	GND
GND	58	57	NC
LPC_FRAME#/ESPI_CS0#	56	55	NC
LPC_SERIRQ/ESPI_CS1#	54	53	GND
LPC_DRQ0#/ESPI_ALERT0	52	51	NC
LPC_AD3/ESPI_IO_3	50	49	NC
LPC_AD2/ESPI_IO_2	48	47	GND
LPC_AD1/ESPI_IO_1	46	45	NC
LPC_AD0/ESPI_IO_0	44	43	NC
IET_CLK	42	41	SLP_S3#
ESPI_RESET#	40	39	CB_RST#
NC	38	37	WAKE1#
NC	36	35	SMB_DAT
NC	34	33	SMB_CLK
NC	32	31	GND
NC	30	29	NC
NC	28	27	NC
GND	26	25	GND
NC	24	23	NC
NC	22	21	NC
GND	20	19	GND
NC	18	17	NC
NC	16	15	NC
GND	14	13	GND
NC	12	11	NC
NC	10	9	NC
GND	8	7	GND
NC	6	5	NC
NC	4	3	NC
GND	2	1	GND

### 2.3.19 COM Express connector (CN1)

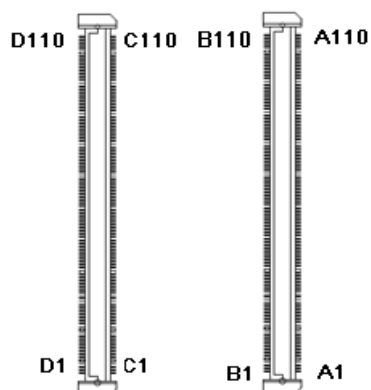
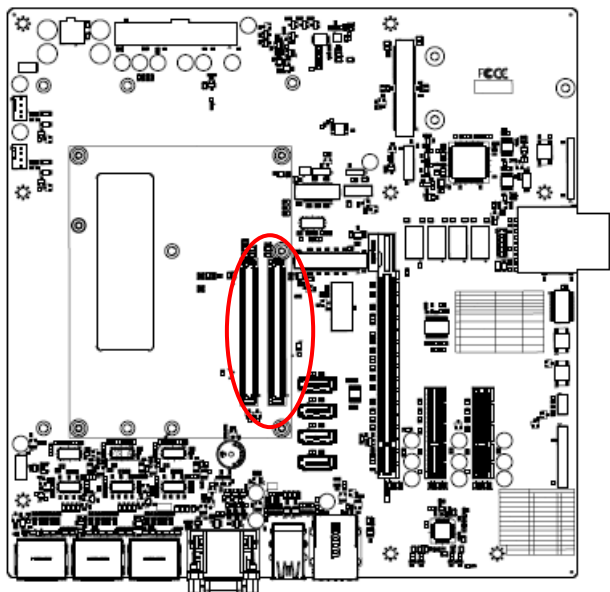

Signal	PIN	PIN	Signal
GND	B110	A110	GND
VCC	B109	A109	VCC
VCC	B108	A108	VCC
VCC	B107	A107	VCC
VCC	B106	A106	VCC
VCC	B105	A105	VCC
VCC	B104	A104	VCC
SLEEP#	B103	A103	LID#
FAN_TACHIN	B102	A102	SER1_RX
FAN_PWMOUT	B101	A101	SER1_TX
GND	B100	A100	GND
NC	B99	A99	SER0_RX
NC	B98	A98	SER0_TX
SPI_CS#	B97	A97	NC
VGA_I2C_DAT	B96	A96	TPM_PP
VGA_I2C_CK	B95	A95	SPI_MOSI
VGA_VSYNC	B94	A94	SPI_CLK
VGA_HSYNC	B93	A93	GPO0/SD_CLK
VGA_BLU	B92	A92	SPI_MISO
VGA_GRN	B91	A91	SPI_POWER
GND	B90	A90	GND
VGA_RED	B89	A89	PCIE_CLK_REF-
BIOS_DIS1#	B88	A88	PCIE_CLK_REF+
+VCC_5VSB	B87	A87	EDP_HDP
+VCC_5VSB	B86	A86	NC
+VCC_5VSB	B85	A85	GPI3/SD_DATA3
+VCC_5VSB	B84	A84	LVDS_I2C_DAT/EDP_AUX-
LVDS_BKLT_CTRL/ EDP_BKLT_CTRL	B83	A83	LVDS_I2C_CK/EDP_AUX+
LVDS_B_CK-	B82	A82	LVDS_A_CK-/EDP_TX3-
LVDS_B_CK+	B81	A81	LVDS_A_CK+/EDP_TX3+

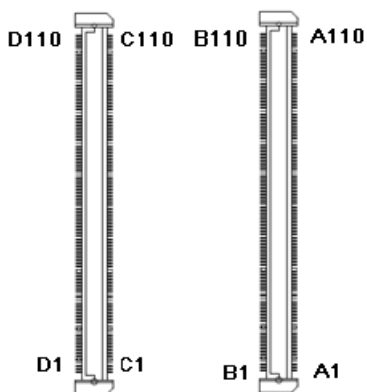
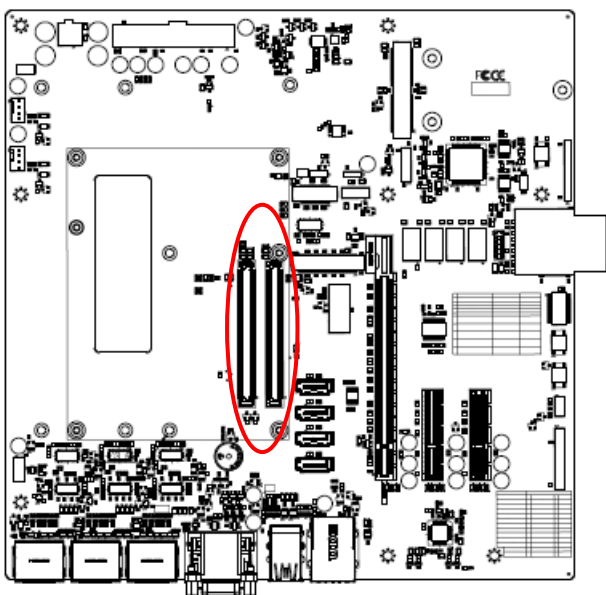

Signal	PIN	PIN	Signal
GND	B80	A80	GND
LVDS_BKLT_EN/ EDP_BKLT_EN	B79	A79	LVDS_A3-
LVDS_B3-	B78	A78	LVDS_A3+
LVDS_B3+	B77	A77	LVDS_VDD_EN /EDP_VDD_EN
LVDS_B2-	B76	A76	LVDS_A2-/EDP_TX0-
LVDS_B2+	B75	A75	LVDS_A2+/EDP_TX0+
LVDS_B1-	B74	A74	LVDS_A1-/EDP_TX1-
LVDS_B1+	B73	A73	LVDS_A1+/EDP_TX1+
LVDS_B0-	B72	A72	LVDS_A0-/EDP_TX2-
LVDS_B0+	B71	A71	LVDS_A0+/EDP_TX2+
GND	B70	A70	GND
PCIE_RX0-	B69	A69	PCIE_TX0-
PCIE_RX0+	B68	A68	PCIE_TX0+
WAKE1#	B67	A67	GPI2/SD_DATA2
WAKE0#	B66	A66	GND
PCIE_RX1-	B65	A65	PCIE_TX1-
PCIE_RX1+	B64	A64	PCIE_TX1+
GPO3/SD_CD#	B63	A63	GPI1/SD_DATA1
PCIE_RX2-	B62	A62	PCIE_TX2-
PCIE_RX2+	B61	A61	PCIE_TX2+
GND	B60	A60	GND
PCIE_RX3-	B59	A59	PCIE_TX3-
PCIE_RX3+	B58	A58	PCIE_TX3+
GPO2/SD_WP	B57	A57	GND
PCIE_RX4-	B56	A56	PCIE_TX4-
PCIE_RX4+	B55	A55	PCIE_TX4+
GPO1/SD_CMD	B54	A54	GPI0/SD_DATA0
PCIE_RX5-	B53	A53	PCIE_TX5-
PCIE_RX5+	B52	A52	PCIE_TX5+
GND	B51	A51	GND



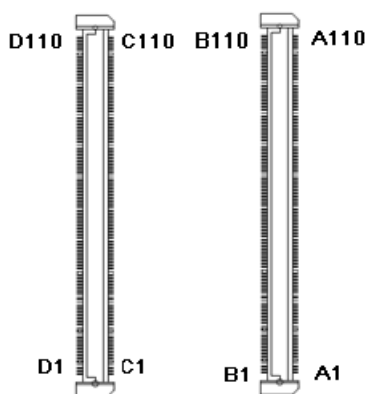
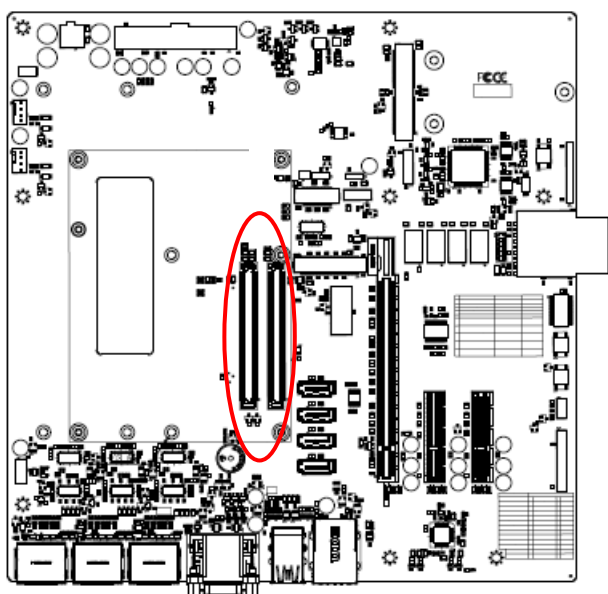

Signal	PIN	PIN	Signal
CB_RESET#	B50	A50	LPC_SERIRQ/ ESPI_CS1#
SYS_RESET#	B49	A49	GBE0_SDP
USB0_HOST_PRSENT	B48	A48	NC
ESPI_EN#	B47	A47	+3.3V
USB1+	B46	A46	USB0+
USB1-	B45	A45	USB0-
USB_0_1_OC#	B44	A44	USB_2_3_OC#
USB3+	B43	A43	USB2+
USB3-	B42	A42	USB2-
GND	B41	A41	GND
USB5+	B40	A40	USB4+
USB5-	B39	A39	USB4-
USB_4_5_OC#	B38	A38	USB_6_7_OC#
USB7+	B37	A37	USB6+
USB7-	B36	A36	USB6-
THRM#	B35	A35	THRMTRIP#
I2C_DAT	B34	A34	BIOS_DIS0#/ ESPI_SAFS
I2C_CLK	B33	A33	HDA_SDOUT
HDA_SPKR	B32	A32	HDA_BITCLK
GND	B31	A31	GND
HDA_SDIN0	B30	A30	HDA_RST#
HDA_SDIN1	B29	A29	HDA_SYNC
HDA_SDIN2	B28	A28	SATA_ACT#
WDT	B27	A27	BATLOW#
SATA3_RX-	B26	A26	SATA2_RX-
SATA3_RX+	B25	A25	SATA2_RX+
PWR_OK	B24	A24	SUS_S5#
SATA3_TX-	B23	A23	SATA2_TX-
SATA3_TX+	B22	A22	SATA2_TX+
GND	B21	A21	GND

# EEV-EX16 User's Manual

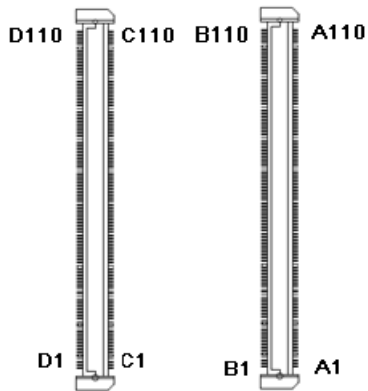
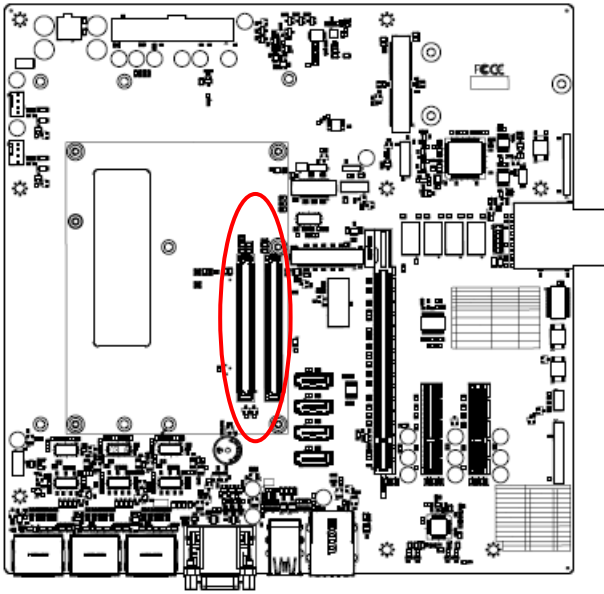

Signal	PIN	PIN	Signal
SATA1_RX-	B20	A20	SATA0_RX-
SATA1_RX+	B19	A19	SATA0_RX+
SUS_STAT#/ESPI_RESET#	B18	A18	SUS_S4#
SATA1_TX-	B17	A17	SATA0_TX-
SATA1_TX+	B16	A16	SATA0_TX+
SMB_ALERT#	B15	A15	SUS_S3#
SMB_DAT	B14	A14	GBE0_CTREF
SMB_CK	B13	A13	GBE0_MDI0+
PWRBTN#	B12	A12	GBE0_MDI0-
GND	B11	A11	GND
LPC_CLK/ESPI_CK	B10	A10	GBE0_MDI1+
LPC_DRQ1#/ESPI_ALERT1#	B9	A9	GBE0_MDI1-
LPC_DRQ0#/ESPI_ALERT0#	B8	A8	GBE0_LINK#
LPC_AD3/ESPI_IO_3	B7	A7	GBE0_MDI2+
LPC_AD2/ESPI_IO_2	B6	A6	GBE0_MDI2-
LPC_AD1/ESPI_IO_1	B5	A5	GBE0_LINK1000#
LPC_AD0/ESPI_IO_0	B4	A4	GBE0_LINK100#
LPC_FRAME#/ESPI_CS0#	B3	A3	GBE0_MDI3+
GBE0_ACT#	B2	A2	GBE0_MDI3-
GND	B1	A1	GND

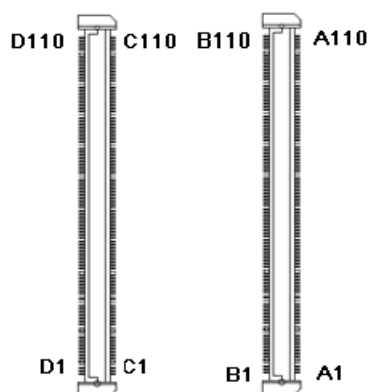
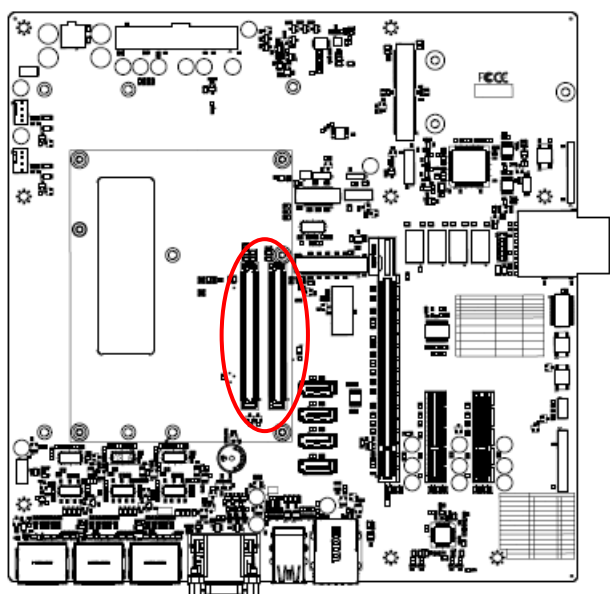

Signal	PIN	PIN	Signal
GND	D110	C110	GND
+VIN	D109	C109	+VIN
+VIN	D108	C108	+VIN
+VIN	D107	C107	+VIN
+VIN	D106	C106	+VIN
+VIN	D105	C105	+VIN
+VIN	D104	C104	+VIN
GND	D103	C103	GND
PEG_TX15-	D102	C102	PEG_RX15-
PEG_TX15+	D101	C101	PEG_RX15+
GND	D100	C100	GND
PEG_TX14-	D99	C99	PEG_RX14-
PEG_TX14+	D98	C98	PEG_RX14+
RSVD30	D97	C97	NC
GND	D96	C96	GND
PEG_TX13-	D95	C95	PEG_RX13-
PEG_TX13+	D94	C94	PEG_RX13+
GND	D93	C93	GND
PEG_TX12-	D92	C92	PEG_RX12-
PEG_TX12+	D91	C91	PEG_RX12+
GND	D90	C90	GND
PEG_TX11-	D89	C89	PEG_RX11-
PEG_TX11+	D88	C88	PEG_RX11+
GND	D87	C87	GND
PEG_TX10-	D86	C86	PEG_RX10-
PEG_TX10+	D85	C85	PEG_RX10+
GND	D84	C84	GND
NC	D83	C83	NC
PEG_TX9-	D82	C82	PEG_RX9-
PEG_TX9+	D81	C81	PEG_RX9+

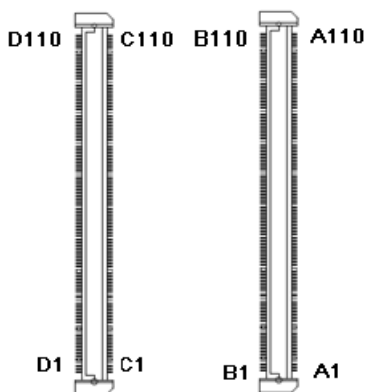
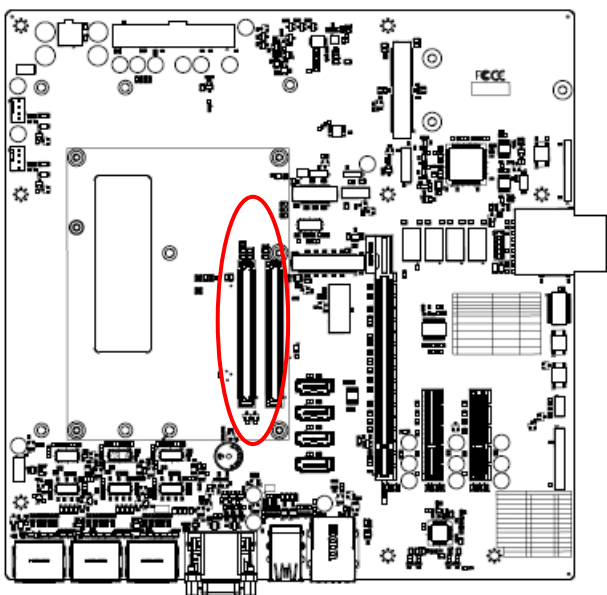

Signal	PIN	PIN	Signal
GND	D80	C80	GND
PEG_TX8-	D79	C79	PEG_RX8-
PEG_TX8+	D78	C78	PEG_RX8+
NC	D77	C77	NC
GND	D76	C76	GND
PEG_TX7-	D75	C75	PEG_RX7-
PEG_TX7+	D74	C74	PEG_RX7+
GND	D73	C73	GND
PEG_TX6-	D72	C72	PEG_RX6-
PEG_TX6+	D71	C71	PEG_RX6+
GND	D70	C70	GND
PEG_TX5-	D69	C69	PEG_RX5-
PEG_TX5+	D68	C68	PEG_RX5+
GND	D67	C67	RAPID_SHUTDOWN
PEG_TX4-	D66	C66	PEG_RX4-
PEG_TX4+	D65	C65	PEG_RX4+
NC	D64	C64	NC
NC	D63	C63	NC
PEG_TX3-	D62	C62	PEG_RX3-
PEG_TX3+	D61	C61	PEG_RX3+
GND	D60	C60	GND
PEG_TX2-	D59	C59	PEG_RX2-
PEG_TX2+	D58	C58	PEG_RX2+
TYPE2#	D57	C57	NC
PEG_TX1-	D56	C56	PEG_RX1-
PEG_TX1+	D55	C55	PEG_RX1+
NC	D54	C54	NC
PEG_TX0-	D53	C53	PEG_RX0-
PEG_TX0+	D52	C52	PEG_RX0+
GND	D51	C51	GND

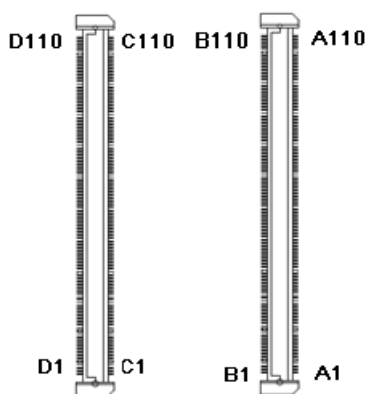
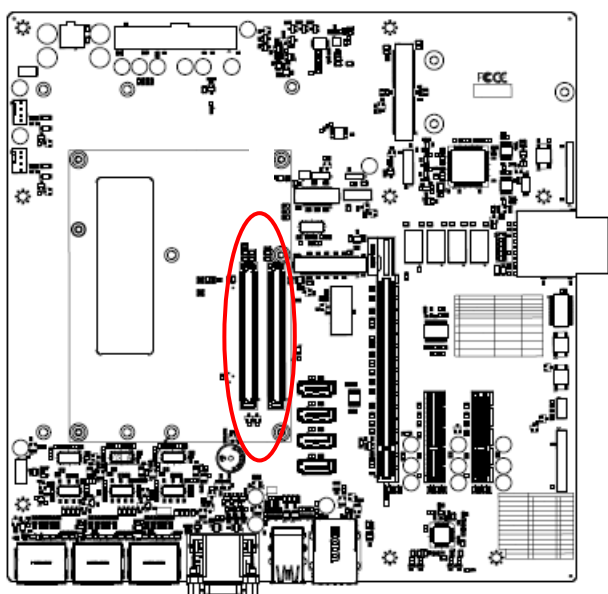

Signal	PIN	PIN	Signal
DDI2_PAIR3-	D50	C50	DDI3_PAIR3-
DDI2_PAIR3+	D49	C49	DDI3_PAIR3+
NC	D48	C48	NC
DDI2_PAIR2-	D47	C47	DDI3_PAIR2-
DDI2_PAIR2+	D46	C46	DDI3_PAIR2+
NC	D45	C45	NC
DDI2_HPDP	D44	C44	DDI3_HPDP
DDI2_PAIR1-	D43	C43	DDI3_PAIR1-
DDI2_PAIR1+	D42	C42	DDI3_PAIR1+
GND	D41	C41	GND
DDI2_PAIR0-	D40	C40	DDI3_PAIR0-
DDI2_PAIR0+	D39	C39	DDI3_PAIR0+
NC	D38	C38	DDI3_DDC_AUX_SEL
DDI1_PAIR3-	D37	C37	DDI3_CTRLDATA_AUX-
DDI1_PAIR3+	D36	C36	DDI3_CTRLCLK_AUX+
NC	D35	C35	NC
DDI1_DDC_AUX_SEL	D34	C34	DDI2_DDC_AUX_SEL
DDI1_PAIR2-	D33	C33	DDI2_CTRLDATA_AUX-
DDI1_PAIR2+	D32	C32	DDI2_CTRLCLK_AUX+
GND	D31	C31	GND
DDI1_PAIR1-	D30	C30	NC
DDI1_PAIR1+	D29	C29	NC
NC	D28	C28	NC
DDI1_PAIR0-	D27	C27	PEG_GEN3_RESET#
DDI1_PAIR0+	D26	C26	NC
NC	D25	C25	NC
NC	D24	C24	DDI1_HPDP
PCIE_TX7-	D23	C23	PCIE_RX7-
PCIE_TX7+	D22	C22	PCIE_RX7+
GND	D21	C21	GND

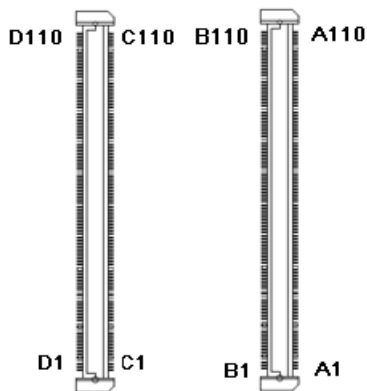
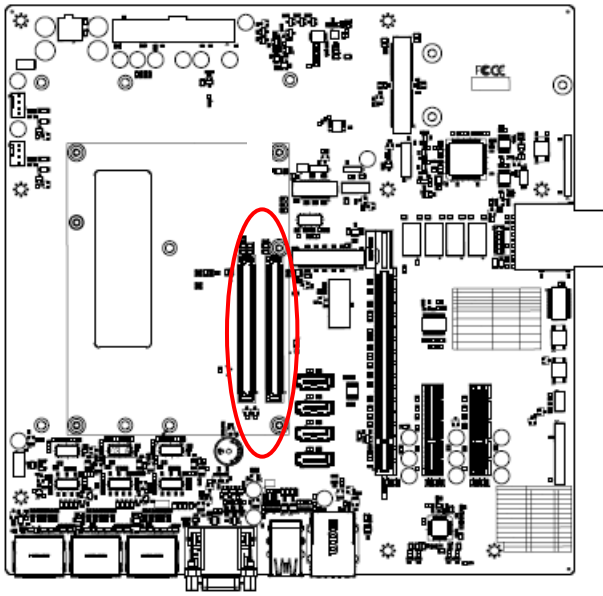

Signal	PIN	PIN	Signal
PCIE_TX6-	D20	C20	PCIE_RX6-
PCIE_TX6+	D19	C19	PCIE_RX6+
NC	D18	C18	NC
NC	D17	C17	NC
DDI1_CTRLDATA_AUX-	D16	C16	NC
DDI1_CTRLCLK_AUX+	D15	C15	NC
GND	D14	C14	GND
USB_SSTX3+	D13	C13	USB_SSRX3+
USB_SSTX3-	D12	C12	USB_SSRX3-
GND	D11	C11	GND
USB_SSTX2+	D10	C10	USB_SSRX2+
USB_SSTX2-	D9	C9	USB_SSRX2-
GND	D8	C8	GND
USB_SSTX1+	D7	C7	USB_SSRX1+
USB_SSTX1-	D6	C6	USB_SSRX1-
GND	D5	C5	GND
USB_SSTX0+	D4	C4	USB_SSRX0+
USB_SSTX0-	D3	C3	USB_SSRX0-
GND	D2	C2	GND
GND	D1	C1	GND

### 2.3.19.1 Signal Description – COM Express connector (CN1)

#### 2.3.19.1.1 Audio Signals

Signal	Signal Description
HDA_SYNC	HD Audio Sync
HDA_RST#	HD Audio Reset

#### 2.3.19.1.2 Gigabit Ethernet Signals

Signal	Signal Description																				
GBE0_MD[0:3] +/-	Gigabit Ethernet Controller 0: Media Dependent Interface Differential Pairs 0,1,2,3. The MDI can operate in 1000, 100 and 10 Mbit / sec modes. Some pairs are unused in some modes, per the following:																				
	<table border="1"> <thead> <tr> <th></th> <th>1000B-T</th> <th>100B-T</th> <th>10B-T</th> </tr> </thead> <tbody> <tr> <td>MDI[0] +/-</td> <td>B1_DA+ /</td> <td>TX+ / -</td> <td>TX+ / -</td> </tr> <tr> <td>MDI[1] + /</td> <td>B1_DB+ /</td> <td>RX+ / -</td> <td>RX+ / -</td> </tr> <tr> <td>MDI[2] + /</td> <td>B1_DC+ /</td> <td>X</td> <td>X</td> </tr> <tr> <td>MDI[3] + /</td> <td>B1_DD+ /</td> <td>X</td> <td>X</td> </tr> </tbody> </table>		1000B-T	100B-T	10B-T	MDI[0] +/-	B1_DA+ /	TX+ / -	TX+ / -	MDI[1] + /	B1_DB+ /	RX+ / -	RX+ / -	MDI[2] + /	B1_DC+ /	X	X	MDI[3] + /	B1_DD+ /	X	X
		1000B-T	100B-T	10B-T																	
	MDI[0] +/-	B1_DA+ /	TX+ / -	TX+ / -																	
	MDI[1] + /	B1_DB+ /	RX+ / -	RX+ / -																	
MDI[2] + /	B1_DC+ /	X	X																		
MDI[3] + /	B1_DD+ /	X	X																		
GBE0_ACT#	Gigabit Ethernet Controller 0 activity indicator, active low.																				
GBE0_Link#	Gigabit Ethernet Controller 0 link indicator, active low.																				
GBE0_Link100#	Gigabit Ethernet Controller 0 100 Mbit / sec link indicator, active low.																				
GBE0_Link1000#	Gigabit Ethernet Controller 0 1000 Mbit / sec link indicator, active low.																				

#### 2.3.19.1.3 PCI Express Signals

Signal	Signal Description
PCIE_TX[0:7] +/-	PCI Express Differential Transmit Pair 0-7
PCIE_RX[0:7] +/-	PCI Express Differential Receive Pair 0-7

#### 2.3.19.1.4 Flat Panel LVDS Signals

Signal	Signal Description
LVDS_BKLT_CTRL	Controls panel digital power.
LVDS_I2C_CLK	I2C clock output for LVDS display use.
LVDS_I2C_DAT	I2C data line for LVDS display use.
LVDS_VDD_EN	LVDS panel power enables.

## EEV-EX16 User's Manual

### 2.3.19.1.5 LPC Signals

Signal	Signal Description
LPC_FRAME#/ESPI_CS0#	LPC frame indicates the start of an LPC cycle
LPC_AD[0:3]	LPC multiplexed address, command and data bus
LPC_CLKOUT1	LPC clock output - 33MHz nominal
LPC_SERIRQ	LPC serial interrupt

### 2.3.19.1.6 GPIO Signals

Signal	Signal Description
GPI[0:4]	General purpose input pins.
GPO[0:4]	General purpose output pins.

### 2.3.19.1.7 Power & System Management Signals

Signal	Signal Description
SUS_S3#	Indicates system is in Suspend to RAM state. Active low output.
BATLOW#	Indicates that external battery is low
PWRBTN#	Power button to bring system out of S5 (soft off), active on rising edge.
SMB_SCL_S5	System Management Bus bidirectional clock line.
SMB_SDA_S5	System Management Bus bidirectional data line.
SMB_ALERT#	System Management Bus Alert - input can be used to generate an SMI# (System Management Interrupt) or to wake the system.
SUS_STAT#/ESPI_RESET#	Indicates imminent suspend operation.
PWR_OK	Power OK from main power supply
SYS_RESET#	Reset button input. Active low input.
WAKE0#	PCI Express wake up signal.
WAKE1#	General purpose wake up signal.

### 2.3.19.1.8 SATA Signals

Signal	Signal Description
SATA[0:2]_TX +/-	Serial ATA Channel 0-2 transmit differential pair.
SATA[0:2]_RX +/-	Serial ATA Channel 0-2 receive differential pair.
ATA_ACT#	ATA (parallel and serial) activity indicator, active low.



## 2.3.19.1.9 USB Signals

Signal	Signal Description
USB[0:7] +/-	USB differential pairs, channels 0 through 7
USB_0_1_OC#	USB over-current sense, USB channels 0 and 1
USB_2_3_OC#	USB over-current sense, USB channels 2 and 3
USB_4_5_OC#	USB over-current sense, USB channels 4 and 5
USB_6_7_OC#	USB over-current sense, USB channels 6 and 7

## 2.3.19.1.10 I2C Signals

Signal	Signal Description
I2C_CLK	General purpose I2C port clock output.
I2C_DATA	General purpose I2C port data I/O line.

## 2.3.19.1.11 USB3.0 Signals

Signal	Signal Description
USB_SSTX[0:1]+ USB_SSTX[0:1]-	Additional transmit signal differential pairs for the SuperSpeed USB data path.
USB_SSRX[0:1]+ USB_SSRX[0:1]-	Additional receive signal differential pairs for the SuperSpeed USB data path.

## 2.3.19.1.12 DDI Signals

Signal	Signal Description
DDI0_PAIR[0:2]+ DDI0_PAIR[0:2]-	Digital Display Interface0 Pair[0:2] differential pairs
DDI0_DDC_AUX_SEL	Selects the function of DDI0_CTRLCLK_AUX+ and DDI0_CTRLDATA_AUX-. If this input is floating the AUX pair is used for the DP AUX+/- signals. If pulled-high the AUX pair contains the CTRLCLK and CTRLDATA signals.
DDI0_CTRLCLK_AUX+	DP AUX+function if DDI0_DDC_AUX_SEL is no connect HDMI/DVI 12C CTRLCLK if DDI0_DDC_AUX_SEL is pulled high
DDI0_CTRLDATA_AUX-	DP AUX-function if DDI0_DDC_AUX_SEL is no connect HDMI/DVI 12C CTRLDATA if DDI0_DDC_AUX_SEL is pulled high
DDI0_HPD	Digital Display Interface Hot-Plug Detect

## EEV-EX16 User's Manual

### 2.3.19.1.13 USB3.0 Signals

Signal	Signal Description
USB_SSTX[0:3]+ USB_SSTX[0:3]-	Additional transmit signal differential pairs for the SuperSpeed USB data path.
USB_SSRX[0:3]+ USB_SSRX[0:3]-	Additional receive signal differential pairs for the SuperSpeed USB data path.

### 2.3.19.1.14 DDI Signals

Signal	Signal Description
DDI[1:3]_PAIR[0:3]+ DDI[1:3]_PAIR[0:3]-	Digital Display Interface 1 to 3Pair[0:3] differential pairs
DDI[1:3]_DDC_AUX_SEL	Selects the function of DDI[1:3]_CTRLCLK_AUX+ and DDI[1:3]_CTRLDATA_AUX-. If this input is floating the AUX pair is used for the DP AUX+/- signals. If pulled-high the AUX pair contains the CTRLCLK and CTRLDATA signals.
DDI[1:3]_CTRLCLK_AUX+	DP AUX+function if DDI[1:3]_DDC_AUX_SEL is no connect HDMI/DVI 12C CTRLCLK if DDI[1:3]_DDC_AUX_SEL is pulled high
DDI[1:3]_CTRLDATA_AUX-	DP AUX-function if DDI[1:3]_DDC_AUX_SEL is no connect HDMI/DVI 12C CTRLDATA if DDI[1:3]_DDC_AUX_SEL is pulled high
DDI[1:3]_HPD	Digital Display Interface Hot-Plug Detect

### 2.3.19.1.15 PEG PCI Express Lanes Signals

Signal	Signal Description
PEG_TX[0:15]+ PEG_TX[0:15]-	PCI Express Graphics transmit differential paris.
PEG_RX[0:15]+ PEG_RX[0:15]-	PCI Express Graphics recevie differential paris.

## 2.4 EEV-EX16 DB-A PCIe Expansion Boards

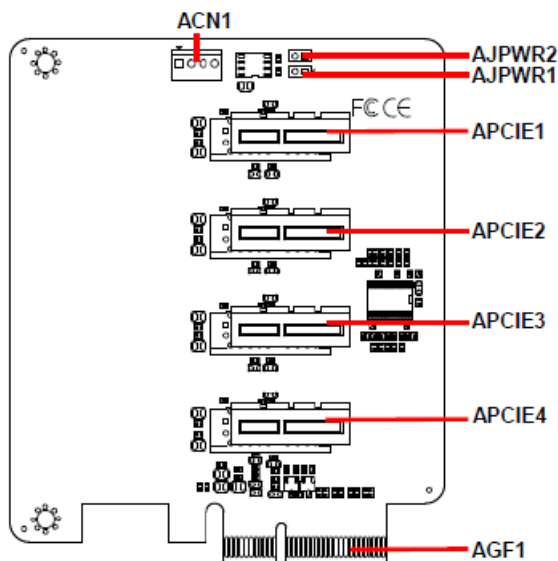

## 2.5 EEV-EX16 Expansion Boards Jumper & Connector list

### Jumpers

Label	Function	Note
AJPWR1/2	+12V VIN Power select	2 x 1 header, pitch 2.00mm

### Connectors

Label	Function	Note
APCIE1/2/3/4	PCIE connector (into the PCIE2)	
ACN1	Power connector	4 x 1 wafer, pitch 2.54mm
AGF1	Gold Finger	

## 2.6 EEV-EX16 DB-A PCIe Expansion board Setting

### 2.6.1 +12V VIN Power select (AJPWR1/2)

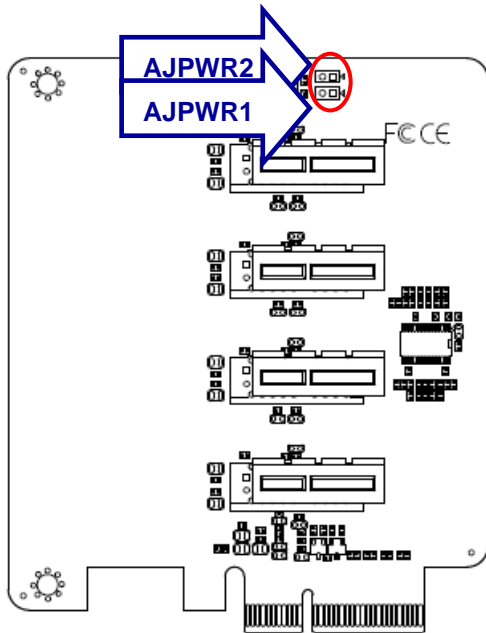

PCIEx4 Power\*    CN1(S4P) Power

AJPWR2

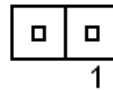

AJPWR2

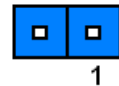

AJPWR1



AJPWR1

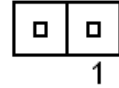

\* Default

### 2.6.2 Power connector (ACN1)

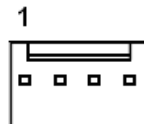
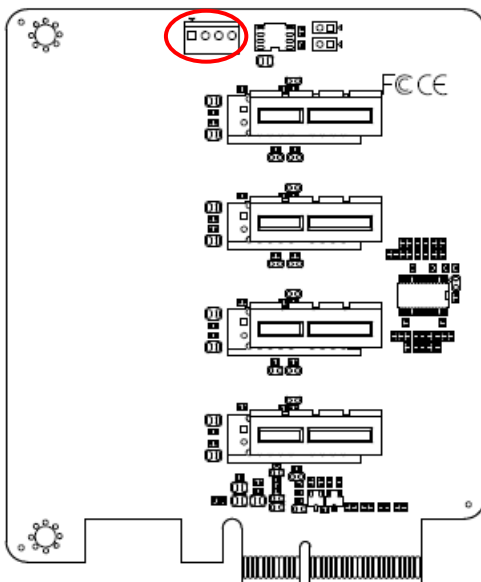

Signal	PIN
NC	1
GND	2
GND	3
+12V	4

### 2.6.3 Gold Finger (AGF1)

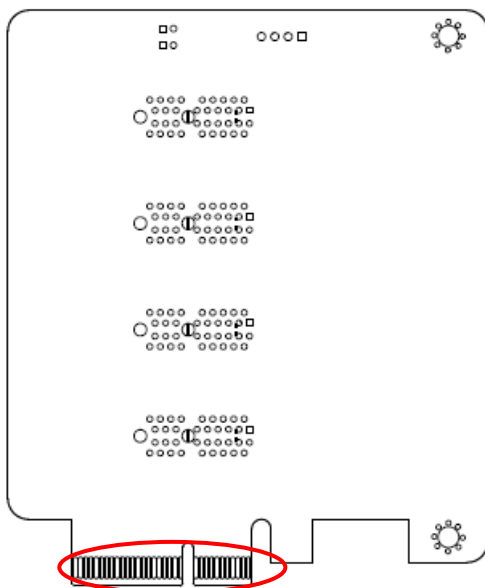
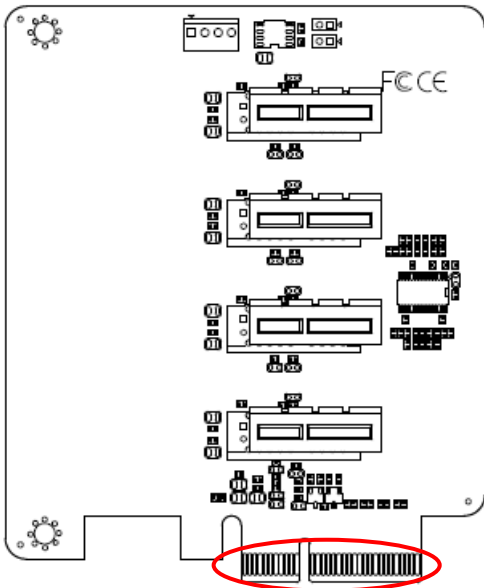

Signal	PIN	PIN	Signal
+12V	B1	A1	GND
+12V	B2	A2	+12V
+12V	B3	A3	+12V
GND	B4	A4	GND
SMB_CLK_P4P1	B5	A5	NC
SMB_DAT_P4P1	B6	A6	NC
GND	B7	A7	NC
+3.3V	B8	A8	NC
NC	B9	A9	+3.3V
+3.3VSB	B10	A10	+3.3V
PCIE_WAKE#_P4P1	B11	A11	CB_RST#_P4P1
NC	B12	A12	GND
GND	B13	A13	PCIE_CLK_REF_P4P1
PCIE_TXP_0_P4P1	B14	A14	PCIE_CLK_REF#_P4P1
PCIE_TXN_0_P4P1	B15	A15	GND
GND	B16	A16	PCIE_RXP_0_P4P1
NC	B17	A17	PCIE_RXN_0_P4P1
GND	B18	A18	GND
PCIE_TXP_1_P4P1	B19	A19	NC
PCIE_TXN_1_P4P1	B20	A20	GND
GND	B21	A21	PCIE_RXP_1_P4P1
GND	B22	A22	PCIE_RXN_1_P4P1
PCIE_TXP_2_P4P1	B23	A23	GND
PCIE_TXN_2_P4P1	B24	A24	GND
GND	B25	A25	PCIE_RXP_2_P4P1
GND	B26	A26	PCIE_RXN_2_P4P1
PCIE_TXP_3_P4P1	B27	A27	GND
PCIE_TXN_3_P4P1	B28	A28	GND
GND	B29	A29	PCIE_RXP_3_P4P1
NC	B30	A30	PCIE_RXN_3_P4P1
NC	B31	A31	GND
GND	B32	A32	NC

# 3. Mechanical Drawing



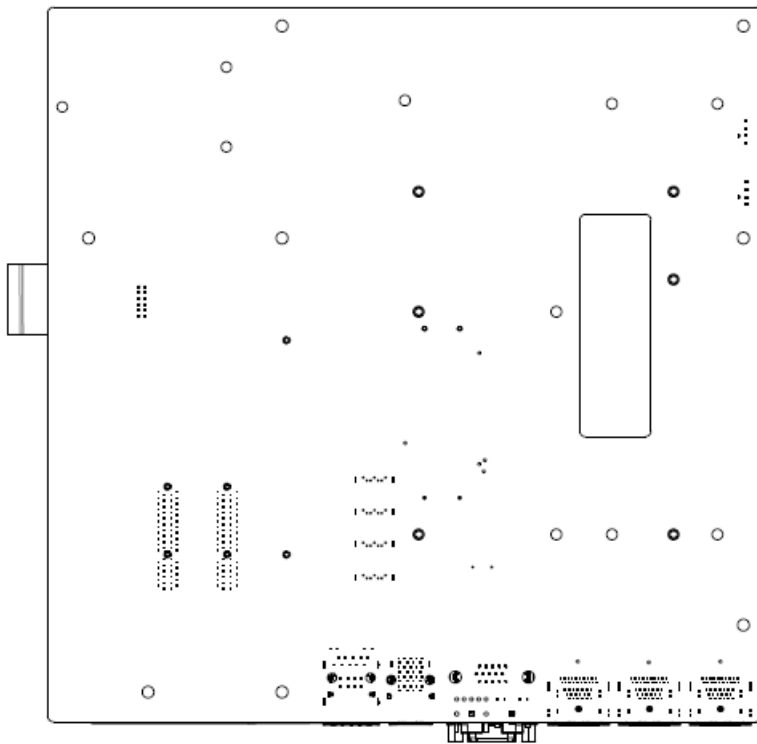
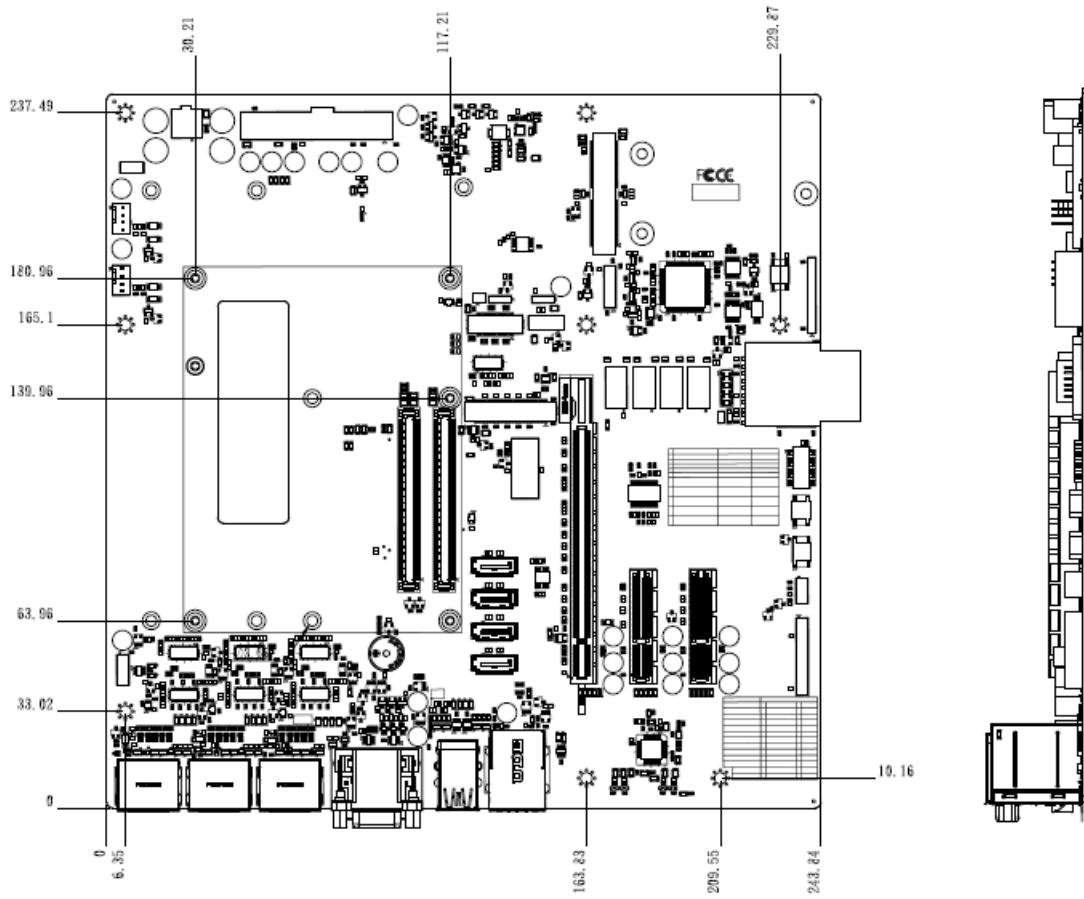

Unit: mm

